

ZX3

ZX3-90PI 12-inch Two-Way Passive 90° x 50°, 600W Weather-Resistant Loudspeaker System



Key Features:

- DVX3121 12" LF Transducer with Forced Air Cooling
- ND2 2" Voice Coil, 1" Exit Neodymium Compression Driver
- 90° x 50° Coverage Pattern
- 600W Continuous (2400W Peak) Power Handling
- High Sensitivity, 131 dB Maximum SPL
- Adjustable Monitor Angle (45° or 55°)
- 2 Anchor Plates for Single Stud Fittings and 7 Integral Suspension Points
- Available in Black or White
- All Weather IEC 529, IP44, & MIL810 Environmental Specs
- Full Line of Accessories



General Description:

The Electro-Voice Zx3 is the new standard of no compromise audio performance and versatility in a simple to use, compact package. The ZX3-90PI features a molded polymer enclosure that is inherently water resistant. The addition of a multilayer grille with hydrophobic cloth and a gland nut input connection allows for a highly weather resistant system.

At its heart are the transducers. First is the DVX3121 high performance low frequency transducer. EV used advanced computer aided design techniques to create forced air, directional voice coil cooling for high power and efficiency. Finite element analysis was used to optimize the suspension and magnetic structure for long, linear travel to provide low distortion and greater LF extension. These features and details, such as forged magnetic components and special materials, provide reliability with a 500W power rating in a lightweight transducer. Next is the ND2, a 2-inch voice coil compression driver based on neodymium motor structure to allow for maximum output while reducing size and weight to a minimum. Its precision phasing plug and titanium diaphragm provide better HF performance, while the integral heatsink provides cooling for high power output.

The high tech enclosure uses injection-molded high-impact polypropylene structural foam to make the Zx3 incredibly durable. The enclosure geometry elements have been carefully designed to provide maximum rigidity and bass response. By design the Zx3 is also a perfect solution for stage monitors by allowing two angles (45° or 55°) without any additional accessories.

Two coverage patterns are available; 60° x 60° coverage for long-throw and cluster applications, 90° x 50° coverage for wider coverage or shorter distances.

The Zx3 is equipped with two anchor plates for rigging with single stud-fittings, along with two more possible anchor plate attachment points on the bottom. For permanent suspension or attaching brackets, the Zx3 also has two M8 inserts on the top and bottom, two under the handle, and one on the back of the enclosure, for a total of 7. All versions are available in black or white.

Technical Specifications:

Freq. Response ¹ (-3 dB):	58 Hz - 15 kHz
Freq. Range ¹ (-10 dB):	48 Hz - 20 kHz
Rec. Hipass Frequency:	50 Hz
Axial Sensitivity ¹ :	97 dB (1W/1m)
Max. Calculated SPL:	131 dB
Coverage (Horiz. x Vert.):	90° x 50°
Power Handling (Passive):	600W Continuous, 2400W Peak
LF Power Handling (Biamp):	500W Continuous, 2000W Peak
HF Power Handling (Biamp):	40W Continuous, 160W Peak
LF Transducer:	DVX3121, 12 in (305mm) Driver
HF Transducer:	ND2, 1 in (25.4mm) exit Neodymium Compression Driver
Crossover Frequency:	2 kHz
Nominal Impedance:	8 Ohms
Minimum Impedance:	6.2 Ohms
Connectors:	2 Conductor SJO Cable and Gland Nut
Enclosure Material:	Polypropylene Structural Foam
Suspension:	Enclosure has locations for 4 Single-Stud Attachment Plates and 7 Forged Steel Eye-bolts - 2 on Top, 2 on Bottom, 2 on Side, and 1 on Rear of Enclosure
Grille:	Polyester Powder Coated, 16GA Galvanized Steel, with Rotatable Logo
Environmental Spec:	IEC 529 IP24 / IP44
Dimensions (H x W x D):	613mm x 397mm x 362mm (24.14" x 15.64" x 14.26")
Net Weight:	19.8 kg (43.7 lbs)
Shipping Weight:	22.1 kg (48.6 lbs)

¹ Half Space Measurement.

Live For Sound
www.electrovoice.com



Zx3-90PI Full Range Loudspeaker

Frequency Response & Impedance:

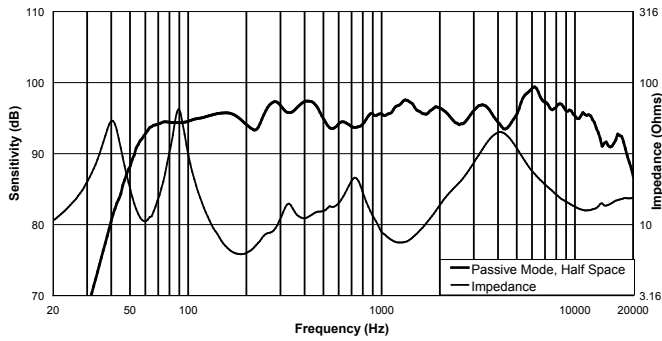

Horizontal Off Axis Frequency Response:

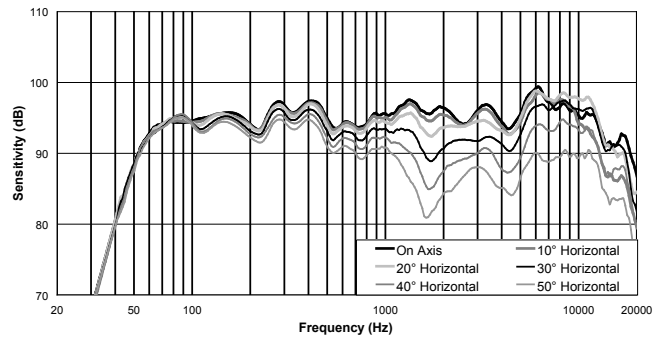

Beamwidth:

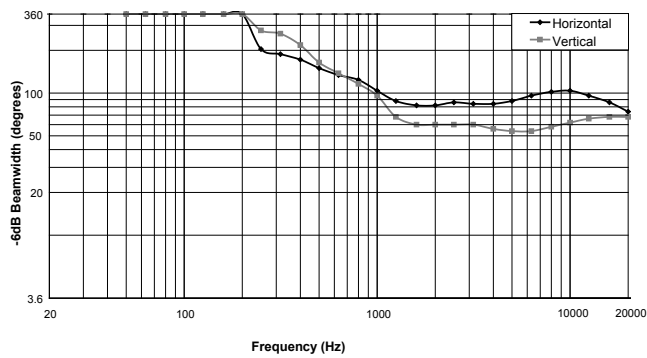

Vertical Off Axis Frequency Response (Up):

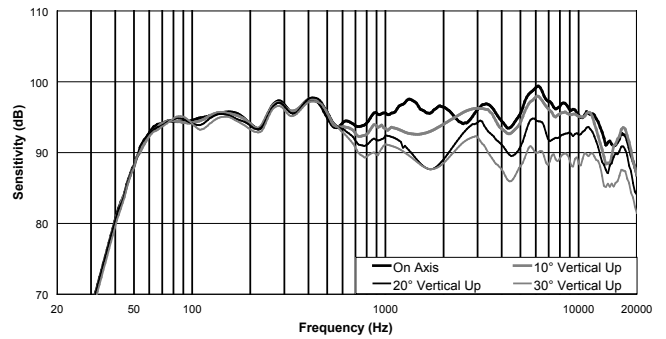

Directivity:

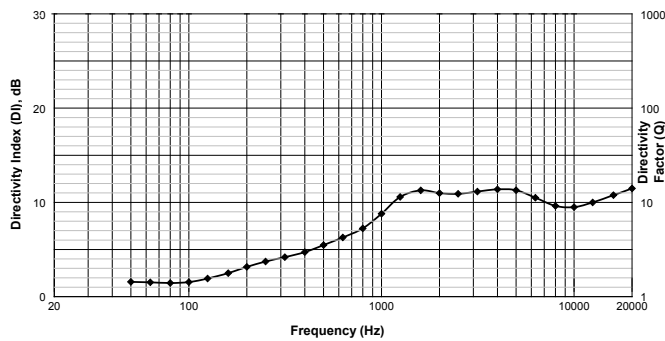

Vertical Off Axis Frequency Response (Down):

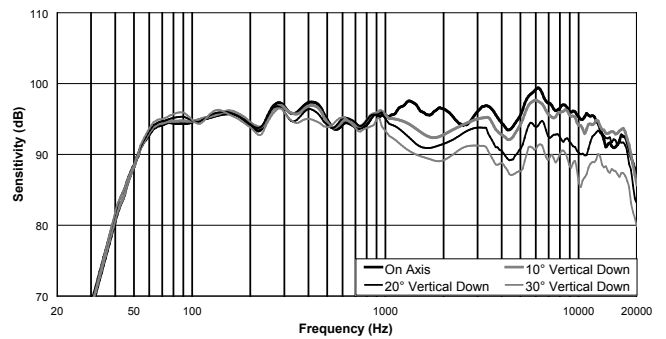

Block Diagram:

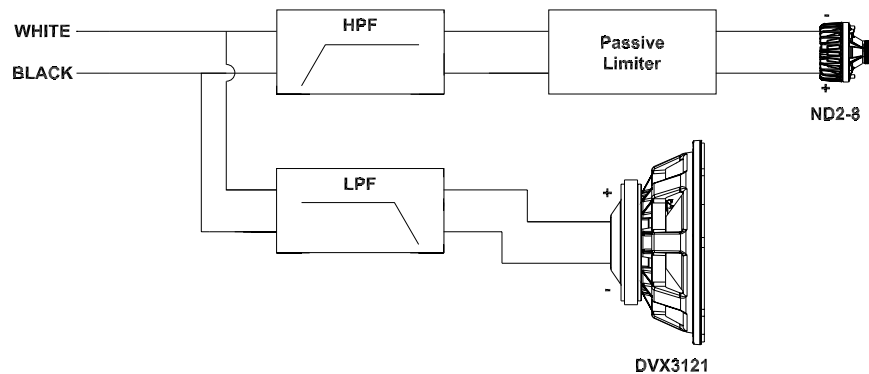

Polar Plots (1/3 Octave):

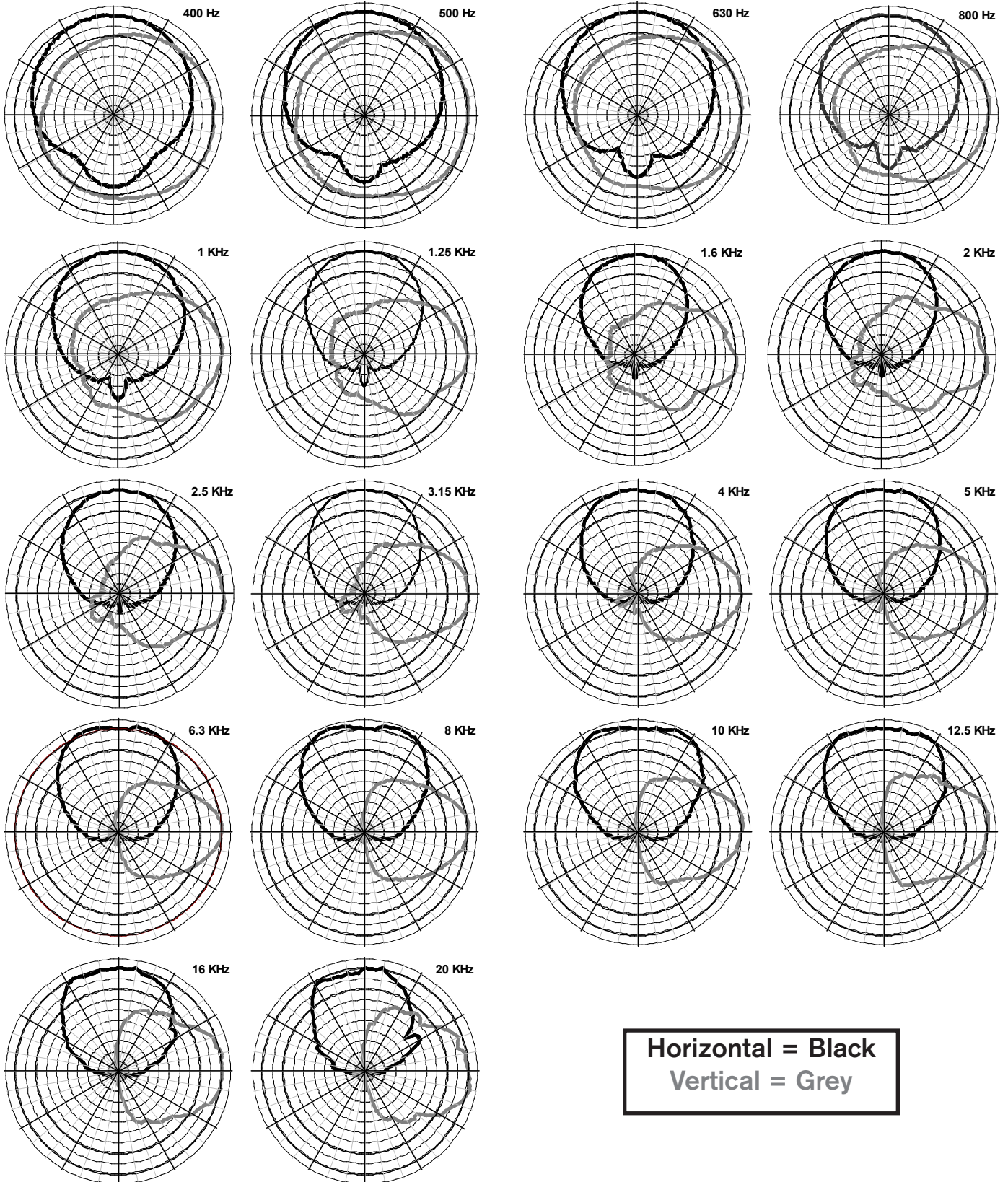

Dimension Drawings:

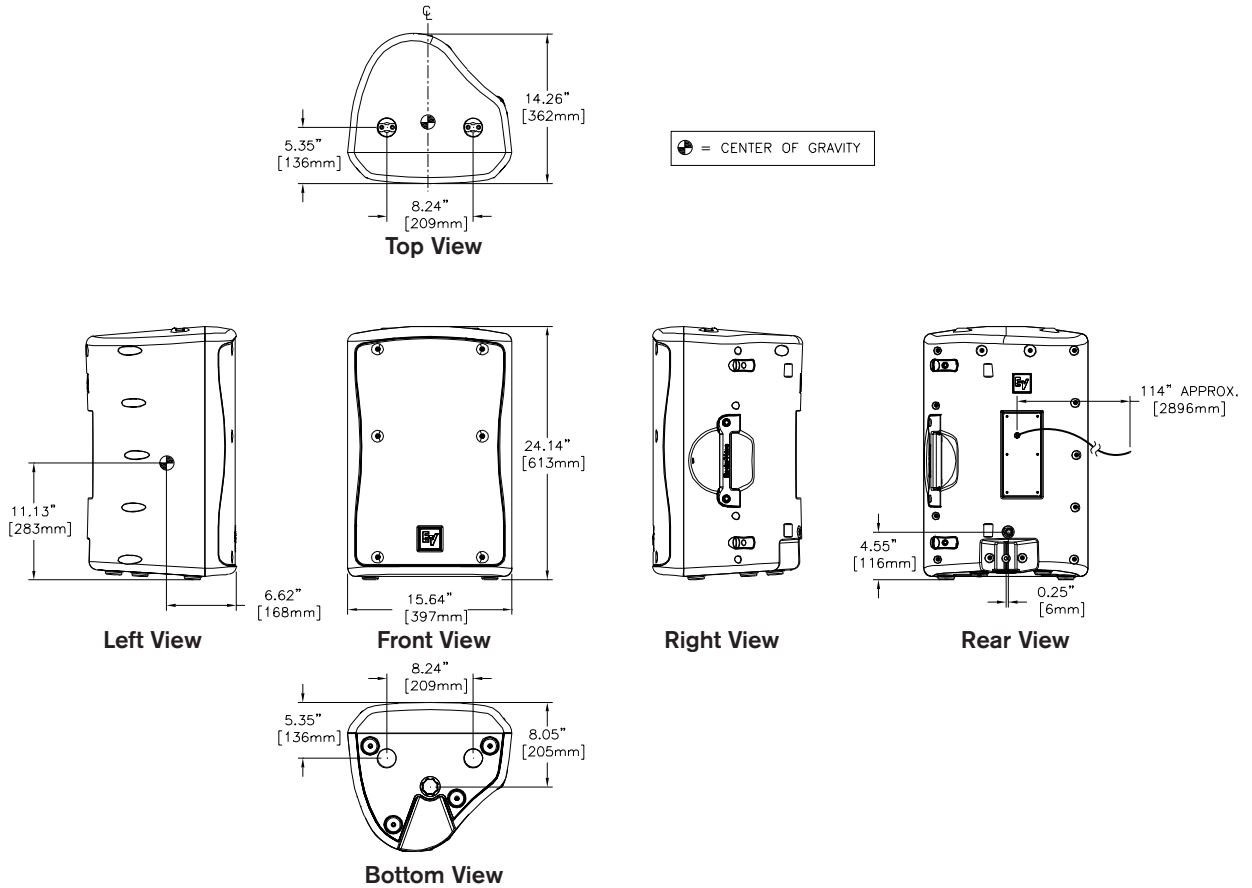

CAUTION

This Zx3 Loudspeaker should be suspended overhead only in accordance with the procedures and limitations specified in the *Zx3 Users Manual* and possible manual update notices. This system should be suspended with certified rigging hardware by an authorized rigging professional and in compliance with local, state, and federal overhead suspension ordinances.

Zx3 Part Numbers

- PRD000117-001 Zx3-90B, 90° x 50° Horn, Black Finish
- PRD000117-002 Zx3-90W, 90° x 50° Horn, White Finish
- PRD000117-003 Zx3-60B, 60° x 60° Horn, Black Finish
- PRD000117-004 Zx3-60W, 60° x 60° Horn, White Finish
- PRD000117-005 Zx3-90PI-B, 90° x 50° Horn, Black Finish, Weather Resistant
- PRD000117-006 Zx3-90PI-W, 90° x 50° Horn, White Finish, Weather Resistant
- PRD000117-007 Zx3-60PI-B, 60° x 60° Horn, Black Finish, Weather Resistant
- PRD000117-008 Zx3-60PI-W, 60° x 60° Horn, White Finish, Weather Resistant

Performance Match

- 301576-001 SbA760, 120V Single 15" Powered Sub, 760W
- D170312 CP3000S, 120V Power Amplifier, 2 x 1100W
- D170401 CP4000S, 120V Power Amplifier, 2 x 1400W
- D170317 CPS2.11, 120V Power Amplifier, 2 x 1100W

Accessories

- 301625-001 CB5-B, Array Bracket Kit (Black)
- 301625-002 CB5-W, Array Bracket Kit (White)
- 301634-000 EBK-3, Forged M8 Eyebolt Kit, Set of Three
- 301633-000 SSK-1, Single-Stud Rigging Kit, Set of Three
- ASY000032-001 MB3-B, Wall/Ceiling Mount Bracket (Black)
- ASY000032-002 MB3-W, Wall/Ceiling Mount Bracket (White)
- ASY000031-001 HDC-3, Heavy-Duty Stackable Cover (Black)
- ACC000012-001 TCA-1, Truss Clamp Adapter
- ACC000007-001 VSA-1, Vertical Strong-Arm Mount
- ACC000033-001 HA-3, Handle Mount Adapter

Electro-Voice

12000 Portland Avenue South, Burnsville, MN 55337
Phone: 952/884-4051, Fax: 952/884-0043

www.electrovoice.com

© Bosch Communications Systems 11/2010
Part Number LIT000172 Rev B

U.S.A. and Canada only. For customer orders, contact Customer Service at:
800/392-3497 Fax: 800/955-6831

Europe, Africa, and Middle East only. For customer orders, contact Customer Service at:
+ 49 9421-706 0 Fax: + 49 9421-706 265

Other International locations. For customer orders, Contact Customer Service at:
+ 1 952 884-4051 Fax: + 1 952 887-9212

For warranty repair or service information, contact the Service Repair department at:
800/685-2606

For technical assistance, contact Technical Support at: 866/78AUDIO

Specifications subject to change without notice.