

SRM350v2

The Mackie SRM350v2 is a full-range, portable, powered loudspeaker system providing high-output, ultra-wide dispersion and low-distortion performance in a compact, lightweight design. Two Fast Recovery™ amplifiers independently power a 10-inch lightweight woofer and a precision titanium compression driver. Mackie's sophisticated Active electronics provide phase correction, crossover, time correction, equalization and protection circuitry.

A heat-treated titanium compression driver directs pristine highs through an exponential high-frequency waveguide, allowing for ultra-wide dispersion. This allows the SRM350v2 to deliver clear, smooth sound to audience members up to 45° off axis.

The 10-inch lightweight woofer provides a greater magnetic field with far less material, making the woofer extremely lightweight without sacrificing performance. The 2-inch voice coil allows the driver to run cooler, delivering consistent performance even after long hours of use.

Mackie-designed Active electronics provide equalization, crossover, time alignment, and phase correction to enhance sonic performance. Protective circuitry includes over-excursion protection, low-line voltage shut-down, thermal protection, dynamic low-frequency bass boost and independent LF and HF limiters.

The SRM350v2 features a number of dedicated controls including a mic/line switch, a single microphone and line input level control, and a contour switch for low-level sound reinforcement applications.

The center of gravity, handle locations, handle design, position of fly-points and ease of use have been ergonomically designed. There is also an integrated pole mount cup and a weather-resistant steel grille. The asymmetrical trapezoidal cabinet has been designed to provide an ideal floor monitoring position.

The cabinet is constructed of high-pressure injected polypropylene. The enclosure features reinforcement ribbing and structural strengthening resulting in a strong, super-rigid design providing ideal acoustical characteristics.

APPLICATIONS

Small club/band PA systems, houses of worship, DJs, vocal/band monitor wedges, gymnasiums, banquet halls, conference rooms and many, many more.



FEATURES:

- 2-way bi-amplified, optimized powered loudspeaker system
- 165W RMS Class-D, Fast Recovery™ LF amp / 30W RMS HF amp
- 10" lightweight long-throw low-frequency transducer with 2" voice coil
- High-output precision titanium compression driver
- Ultra-wide, smooth dispersion via HF waveguide
- Mackie Active electronic time alignment, phase correction and EQ for studio quality sound
- Phase-accurate 24 dB/octave Linkwitz-Riley electronic crossover
- Mic/line input and pass-thru connector
- Lightweight for ultimate portability (24 lb / 10.9 kg)
- Asymmetrical trapezoidal cabinet for floor monitor positioning
- Stand / Pole-mountable
- Flyable via optional hanging bracket kit

SRM350v2 SPECIFICATIONS

Acoustic Performance

| | |
|----------------------------|--|
| Frequency Response (-3 dB) | 83 Hz - 18.5 kHz |
| Frequency Range (-10 dB) | 61 Hz - 22 kHz |
| Max SPL long-term | 118 dB @ 1 m |
| Max SPL peak | 121 dB @ 1 m |
| Crossover Point | Linkwitz-Riley, 24 dB/octave @ 2400 Hz |

Input / Output

| | |
|-------------------|-----------------------|
| Input / Thru Type | Balanced Differential |
| Input Impedance | 94 kΩ |

Sensitivity

| | |
|---|-----------------------------------|
| Line | +4 dBu (center detent) |
| Mic | -36 dBu |
| Maximum Input Level | +22 dBu |
| Acoustic Contour Equalization (Peaking) | +3 dB @ 100 Hz, +3 dB @ 12 kHz |

Low-Frequency Power Amplifier

| | |
|-------------|----------------------|
| Rated Power | 165 watts rms* |
| Rated THD | < 0.03% |
| Cooling | Convection Extrusion |
| Design | Class D |

High-Frequency Power Amplifier

| | |
|-------------|----------------------|
| Rated Power | 30 watts rms* |
| Rated THD | < 0.03% |
| Cooling | Convection Extrusion |
| Design | Class AB |

*Rated power is continuous rms wattage into transducer's rated impedance @ 1kHz for the HF amplifier and @ 100Hz for the LF amplifier.

Low-Frequency Transducer

| | |
|---------------------|----------------|
| Diameter | 10 in / 250 mm |
| Voice Coil Diameter | 2 in / 51 mm |

High-Frequency Transducer

| | |
|--------------------|-----------------------|
| Diaphragm Diameter | 1.4 in / 36 mm |
| Diaphragm Material | Heat treated titanium |

Horn Design

| | |
|---------------------|--|
| Type | Conical and Exponential |
| Mouth Size | 11.1 in / 283 mm (W) x 6.1 in / 154 mm (H) |
| Horizontal Coverage | 90° (1 kHz - 20 kHz) |
| Vertical Coverage | 80° (1 kHz - 20 kHz) |

Line Input Power

| | |
|-------------------|---|
| US, JP | 100 - 120 VAC, 50 - 60 Hz |
| EU, UK, AU | 200 - 240 VAC, 50 - 60 Hz |
| AC Connector | 3-pin IEC 250 VAC |
| Power Consumption | 120 watts with musical program and LIMIT LED blinking |

Control System Function

Electronic Crossover, Phase Alignment, Equalization, Parametric EQ

Safety Features

Low-frequency Dynamic Bass Protection, Power Supply, Amplifier Thermal Protection

Construction Features

| | |
|-----------------------|---|
| Basic Design | Asymmetrical Trapezoidal |
| Enclosure Alignment | Sixth-Order |
| Material | Polypropylene |
| Finish | Black, textured finish |
| Handles | One on right side, one on top |
| Grille | Perforated metal with weather-resistant coating |
| Display LEDs | Signal Present, Power ON, and Limit |
| Operating Temperature | -10°C - 45°C 14°F - 113°F |

Physical Properties (packaged product)

| | |
|-----------------|-------------------|
| Height | 21.5 in / 546 mm |
| Width | 13.2 in / 335 mm |
| Depth | 12.4 in / 315 mm |
| Shipping Weight | 28.0 lb / 12.7 kg |

Physical Properties (product)

| | |
|------------|-------------------|
| Height | 20.8 in / 527 mm |
| Width | 13.1 in / 333 mm |
| Depth | 12.3 in / 311 mm |
| Net Weight | 24.0 lb / 10.9 kg |

Mounting Methods

Floor mount, pole mount, or fly via optional bracket

Options

| | |
|-------------------------------|----------------|
| SPM200 Loudspeaker Pole Mount | P/N 2035170-01 |
| SRM350v2 Bracket | P/N 0016404 |
| SRM350v2 Speaker Bag | P/N 093-024-00 |

Ordering Information

| | |
|---|----------------|
| SRM350v2 10" 2-way Compact SR Loudspeaker, US | P/N 2033797-00 |
| SRM350v2 10" 2-way Compact SR Loudspeaker, EU | P/N 2033797-01 |
| SRM350v2 10" 2-way Compact SR Loudspeaker, JP | P/N 2033797-02 |
| SRM350v2 10" 2-way Compact SR Loudspeaker, UK | P/N 2033797-03 |
| SRM350v2 10" 2-way Compact SR Loudspeaker, AU | P/N 2033797-04 |

SRM350v2 HORIZONTAL POLARS

Gridlines: 6 dB axial / 15 degrees radial

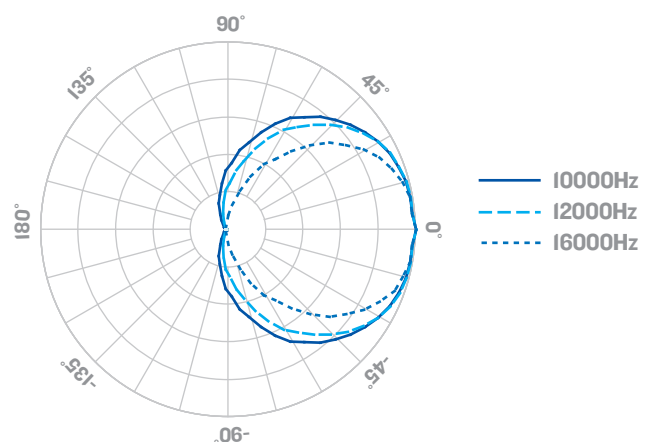
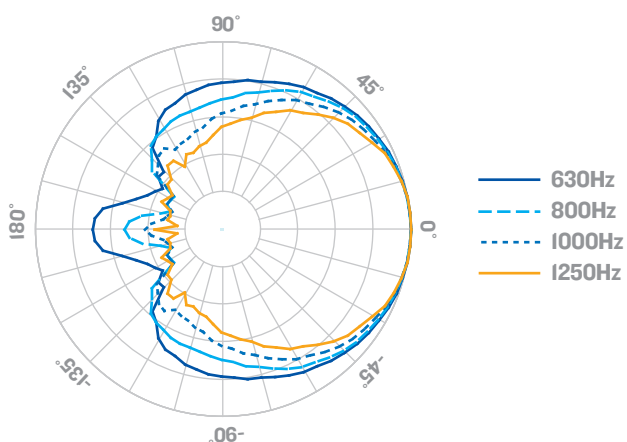
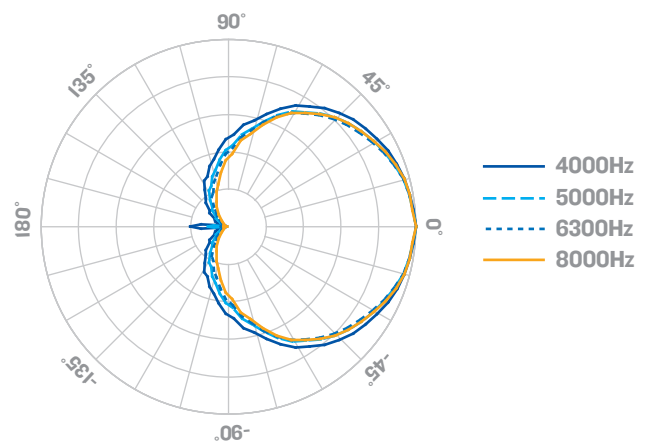
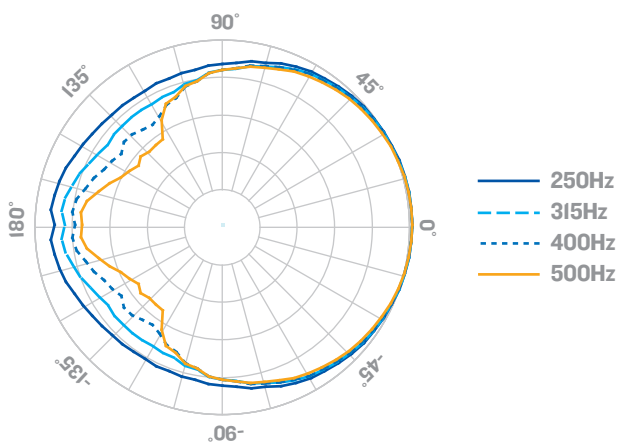
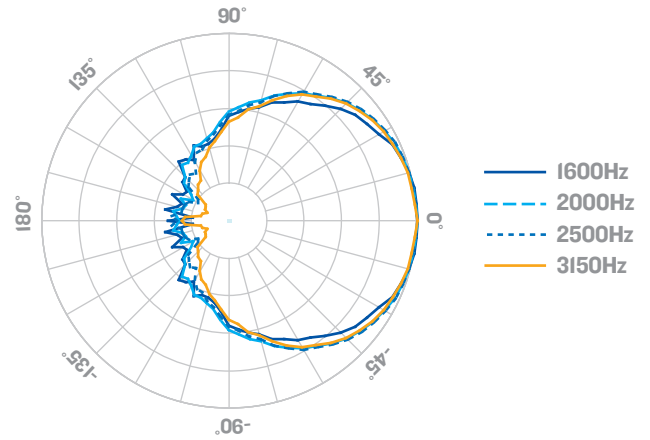
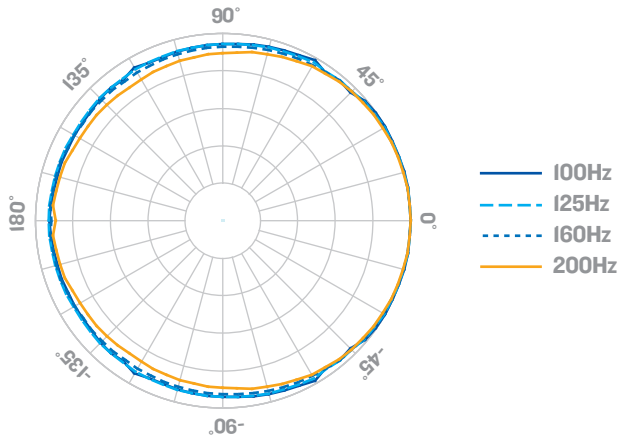

SRM350v2 VERTICAL POLARS

Gridlines: 6 dB axial / 15 degrees radial

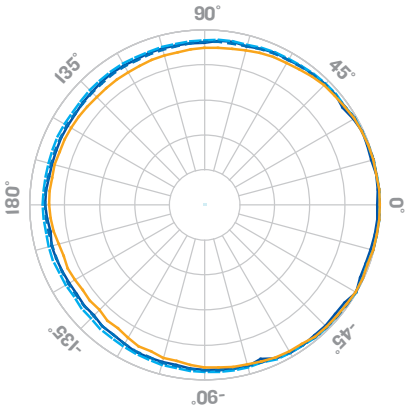

- 100Hz
- - - 125Hz
- · · 160Hz
- 200Hz

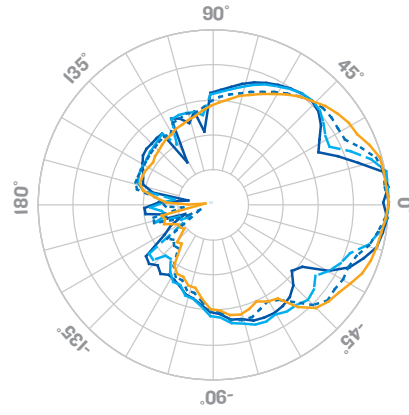

- 1600Hz
- - - 2000Hz
- · · 2500Hz
- 3150Hz

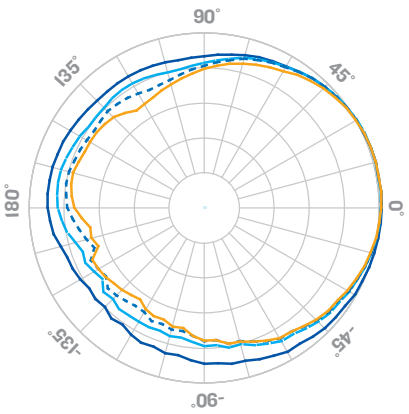

- 250Hz
- - - 315Hz
- · · 400Hz
- 500Hz

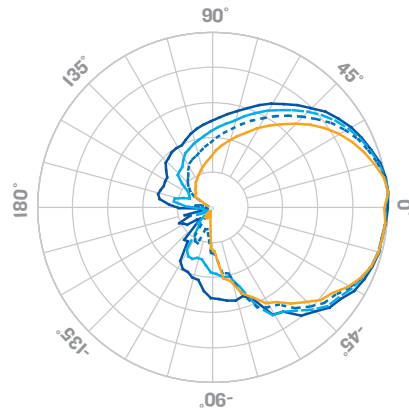

- 4000Hz
- - - 5000Hz
- · · 6300Hz
- 8000Hz

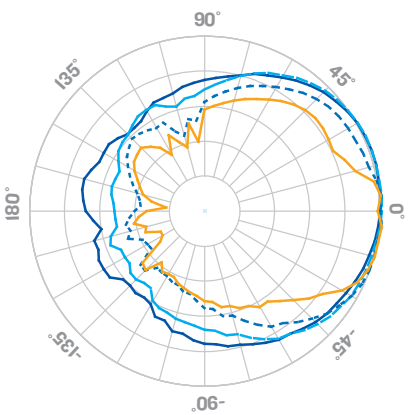

- 630Hz
- - - 800Hz
- · · 1000Hz
- 1250Hz

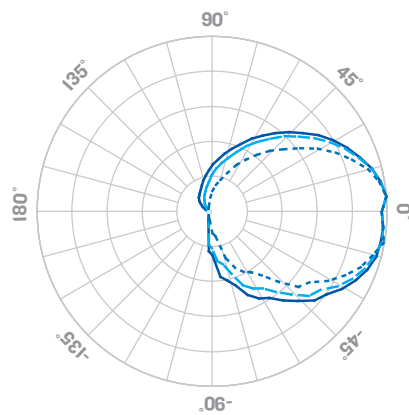

- 10000Hz
- - - 12000Hz
- · · 16000Hz

SRM350v2 FREQUENCY RESPONSE

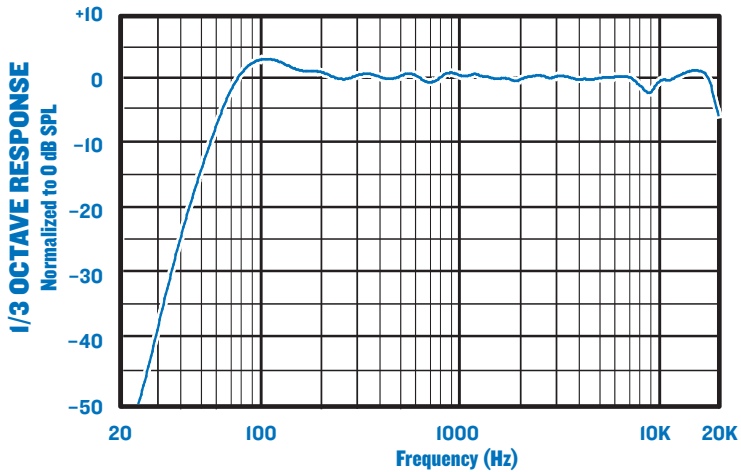

SRM350v2 INPUT PANEL

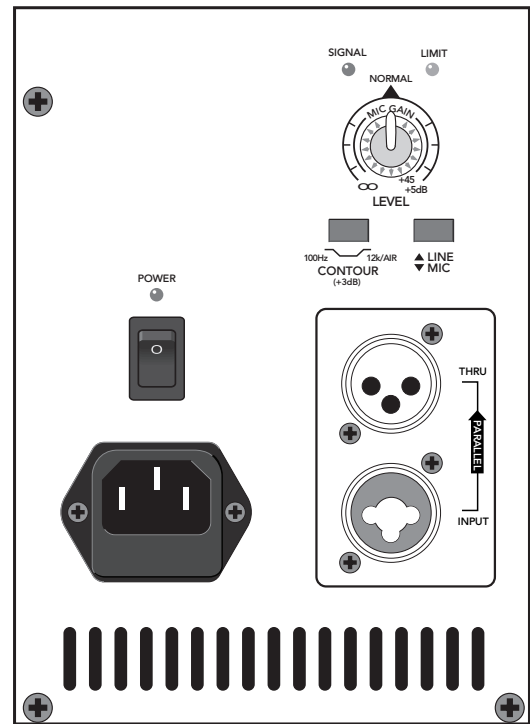

SRM350v2 DIMENSIONS

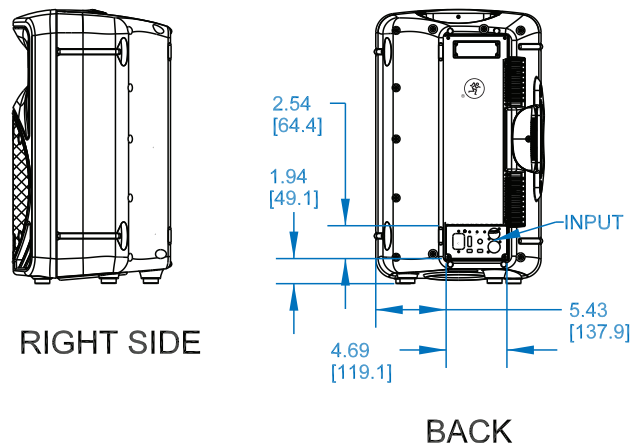
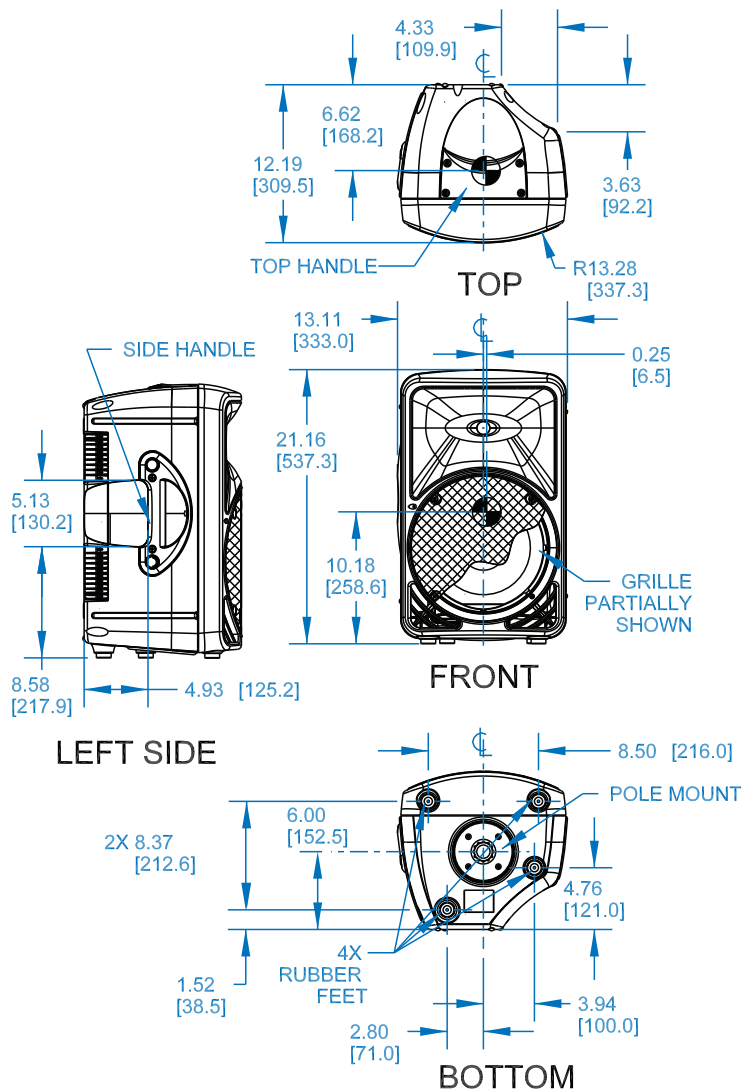

NOTES:

1. SYMBOL INDICATES CENTER OF BALANCE.
2. WEIGHT APPROX. 24.0 lb [10.9 kg].
3. SHIPPING WEIGHT APPROX. 28.0 lb [12.7 kg].

UNLESS OTHERWISE SPECIFIED: ALL DIMENSIONS ARE IN INCHES. DUAL [MM] DIMENSIONS FOR REF ONLY

TOLERANCES
LINEAR ± 0.13 in / ± 3.3 mm; ANGLES $\pm 1^\circ$

(X.XX) = REF DIMS
NO TOLERANCE IMPLIED

TSC=THEORETICAL SHARP CORNER
DIMENSIONS ACROSS CENTERLINES TO BE SYMMETRICAL

SRM350v2 BLOCK DIAGRAM

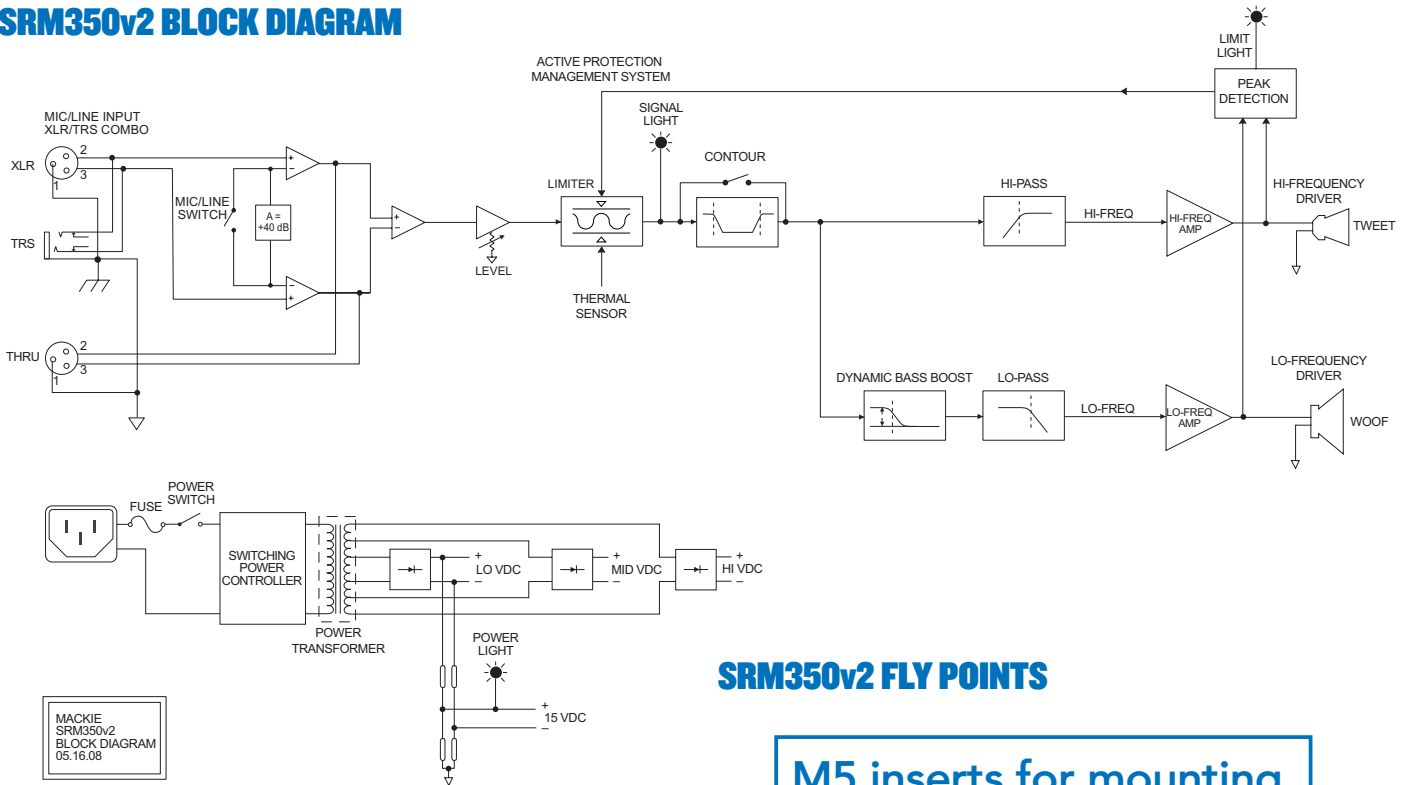

MACKIE
SRM350v2
BLOCK DIAGRAM
05.16.08

SRM350v2 FLY POINTS

M5 inserts for mounting optional hanging bracket

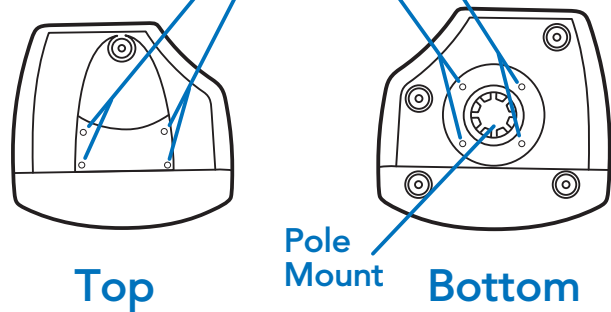

Electronic files for this product are available at:

www.mackie.com

Specification Sheet

SRM350v2_SS.PDF

Owner's Manual

SRM350v2_OM.PDF

MACKIE®

www.mackie.com

16220 Wood-Red Road NE

Woodinville, WA 98072 USA

800-898-3211, Fax 425-487-4337, sales@mackie.com

Part No. SW0763 Rev. C 08/11

©2011 LOUD Technologies Inc. All Rights Reserved.