

Xenon-Zirconia 2.8/89

This lens with 1.0x magnification is optimized for the use with 12k (62.5 mm) line scan sensors with 5 μm pixel, but can also be used with 16k (82 mm) lines. It is broadband coated and can be used in the spectral range of 400 - 1000 nm.

The V-Mount makes it easy to install and rotate into the desired azimuth position for a wide range of line scan applications. Performance is practically diffraction limited over the whole field. At F/#5.6 the lens is free of artificial vignetting. The Xenon-Zirconia lens is designed in a manner that even with fastest F-number, the full resolution, albeit with diminished contrast, is attained, needed for web and FPD inspection.

The Xenon-Zirconia lens series also contains lenses with magnification of 0.2x, 0.33x, 0.5x, 0.7x, 2.0x and 2.0x with beam splitter.

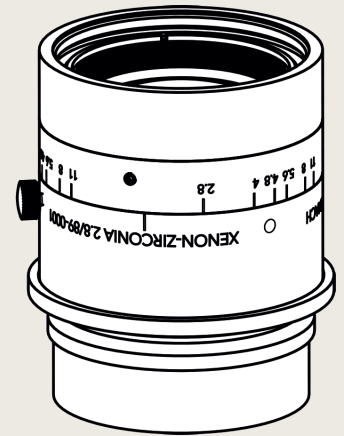

Xenon-Zirconia 2.8/89

Key features

- For 12k line scan sensors with 5 μm pixel sizes
- Vibration-insensitive for stable optical performance
- Best azimuth marking
- 400 nm to 1000 nm broadband AR coating
- Lockable distance and aperture settings
- V-Mount connection

Applications

- Web and surface inspections
- Quality control
- FPD inspection
- PCB inspection
- OLED inspection
- Line scan applications

Name	Xenon-Zirconia 2.8/89
Type	-0001
Focal Length [mm]	89
Magnification	-1
Image circle [mm]	62
Resolution [μm]	5
F/# range	2.8 ... 11
NA	0.18
Interface	V48-Mount
Working distance [mm]	140
AoV [°]	38
Focus control	manual
Transmission [nm]	400 - 1000
Filter thread [mm]	M46 x 0.75
Dimensions L x D [mm]	65.1 x 55.0

Name	Xenon-Zirconia 2.8/89
Weight [g]	250
Storage temperature [°C]	-25 ... +70
f'_{eff} [mm]	88.82
S_F [mm]	-51.86
S'_F [mm]	51.85
HH' [mm]	-20.32
β'_p	1.000
S_{EP} [mm]	36.96
S'_{AP} [mm]	-36.97
Σd [mm]	53.62
ID	1078948

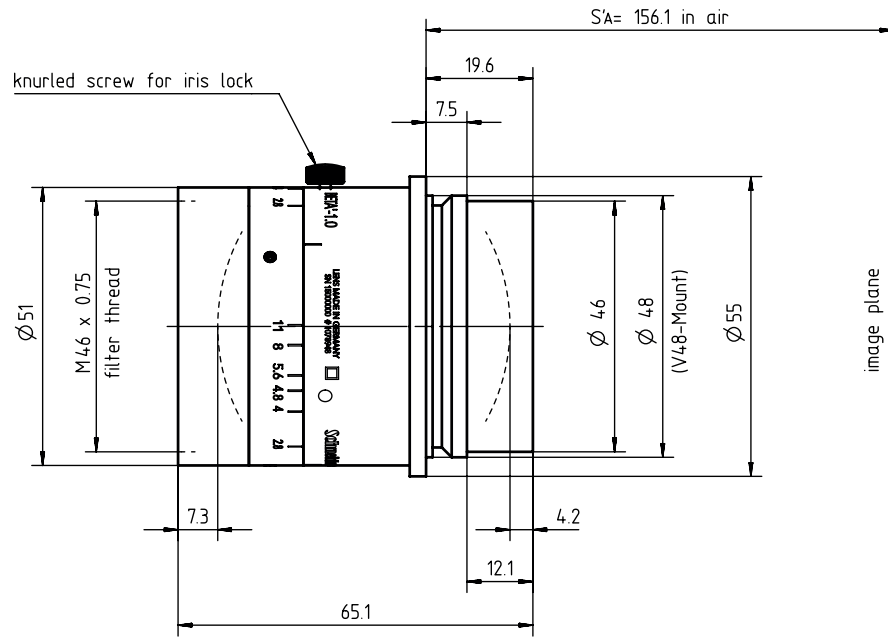

Distortion vs. Image Height Transmittance vs. Wavelength

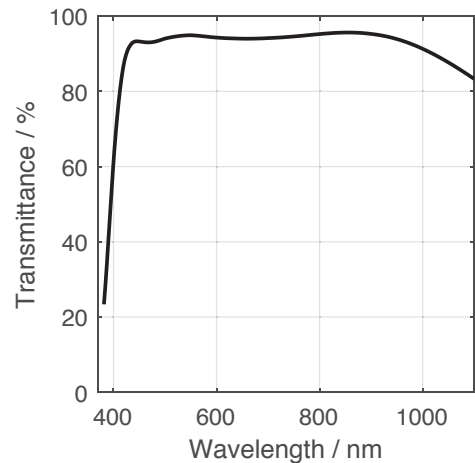
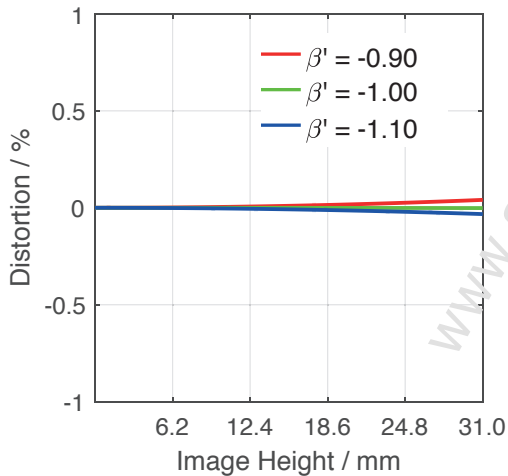

Relative Illumination vs. Image Height

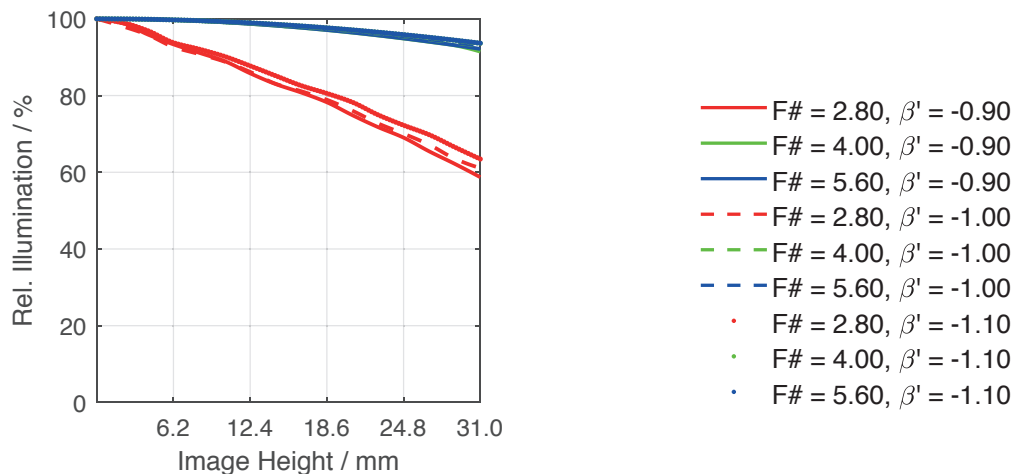

Spectrum Name	VIS					
Wavelengths [nm]	425	475	525	575	625	675
Weights	8	16	23	22	19	13

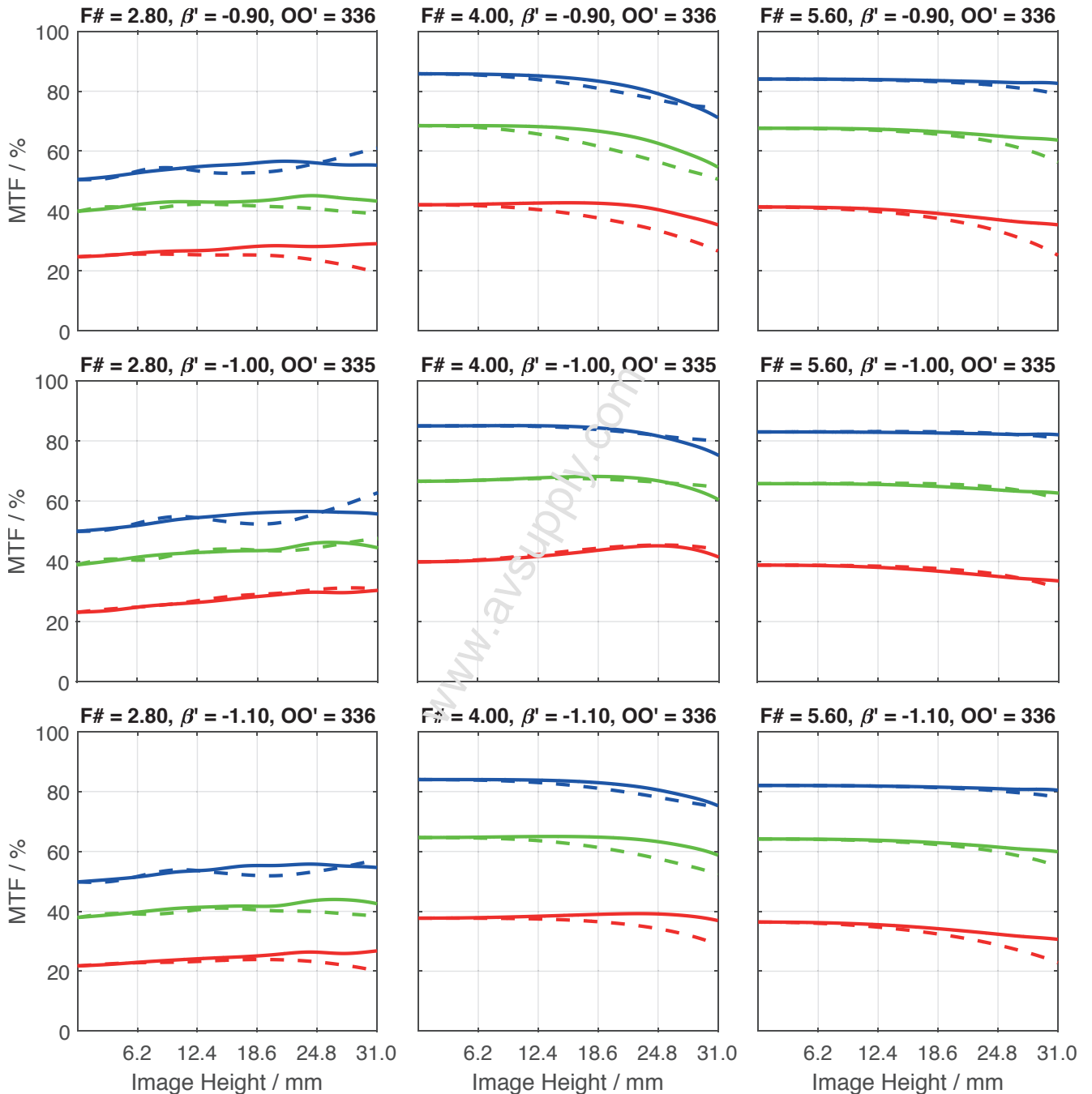

- 18.0 lp/mm, tangential --- 36.0 lp/mm, tangential --- 72.0 lp/mm, tangential
- 18.0 lp/mm, radial — 36.0 lp/mm, radial — 72.0 lp/mm, radial

Accessories	Mount	Length	ID	
Ext. Tube	V48	10 mm	1072661	
	V48	25 mm	1072651	
	V48	50 mm	1072662	
	M72 x 0.75	5 mm	1072420	
	M72 x 0.75	10 mm	1072421	
	M72 x 0.75	25 mm	26406	
	M72 x 0.75	50 mm	1054733	
	M72 x 0.75	100 mm	1079483	
	M90 x 1	10 mm	1084875	
	M90 x 1	25 mm	1084876	
	M90 x 1	50 mm	1084877	
	M90 x 1	100 mm	1084878	
	M95 x 1	10 mm	1077290	
	M95 x 1	25 mm	1062892	
	M95 x 1	50 mm	1062893	
	M95 x 1	100 mm	1062894	
	Adapter	V 48 / C-Mount	8.5 mm	1072650
		V48 / V70 with focusing	10 mm	1075304
V70 / M72 x 0.75		-	1075304	
M72 x 0.75 / M95 x 1		4 mm	1077013	
M72 x 0.75 / M90 x 1		-	1084879	
M95 x 1 / M90 x 1		-	1084889	
V 48 / M 42 x 1		8.5 mm	1072660	
V 48 / M 42 x 0.75		8.5 mm	1072652	
V 48 / M 58 x 0.75		10 mm	1072659	