

HD Security Camera with IR Illuminators and "View-DR"

Sony is pleased to introduce a powerful addition to its network HD camera lineup, the SNC-CH180. This unitized IP66-rated, wide dynamic range camera is designed with a built-in infrared (IR) illuminators.

This dual-stream network camera supports H.264, MPEG-4, and JPEG compression formats, and delivers excellent picture quality in HD 720p resolution at 30 frames per second (fps).

Incorporating the new Exmor™ CMOS image sensor from Sony, which is specially designed for surveillance applications, this camera features state-of-the-art image-enhancement technology, View-DR, which demonstrates an extremely wide dynamic range. Incorporating a built-in IR LED array, it delivers quality images even in absolute darkness (0 lx)*.



Along with a host of superb features such as DEPA™ Advanced, PoE, a built-in heater, and the Easy Focus function, the SNC-CH180 Bullet Network Camera is ideal for the most demanding surveillance applications.



HD

Network HD Bullet Camera — V Series **SNC-CH180**

FEATURES

- Excellent picture quality in HD 720p resolution, supporting H.264 at 30 fps **HD**
- 1.3 Megapixel (1280 x 1024) maximum resolution
- The new Exmor CMOS sensor demonstrates high image quality and high sensitivity for surveillance **Exmor™** 
- Clearly captures objects in the dark - up to 49 feet (15 m) away with the built-in IR illuminators, which allows the camera to operate in 0 lx lighting conditions* (Images 1)
- Wide dynamic range achieved by the innovative View-DR (Visibility Enhanced wide Dynamic Range) technology (Images 2) **View-DR**
 - ▶ Full-capture Wide-D technology - all of the electrons converted from the captured light are fully used
 - ▶ High-speed Exmor CMOS sensor
 - ▶ Visibility Enhancer technology
- The Visibility Enhancer optimizes contrast and makes the subject more visible, even in severe backlight or shadow conditions
- XDNR (eXcellent Dynamic Noise Reduction) technology for clear images without motion blur under low illumination (Images 3)
- Easy Focus / Easy Zoom functions for easy installation
- DEPA Advanced Intelligent Video and Audio Analytics trigger an alarm, based on user-defined rules 
 - ▶ Intelligent Motion Detection
 - ▶ Tamper Alarm
- Three codecs (H.264, MPEG-4, JPEG) with dual streaming capability
- Power over Ethernet (PoE) capability
- CompactFlash® slot for on-board recording/wireless capability using optional SNCA-CFW5 802.11g card
- Built-in heater
- IP66-rated - suitable for use outdoors
- ONVIF™ Software (Open Network Video Interface Forum) **ONVIF**

*0 lx requires the use of IR illuminators.
IR rays are not visible to the human eye.
When the IR illuminators is activated, the image is in black and white.

Drastic Improvement in Visibility

IR Illuminators (Images 1)

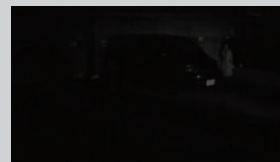

OFF



ON

Actual Images

View-DR (Visibility enhanced wide Dynamic Range) (Images 2) **View-DR**

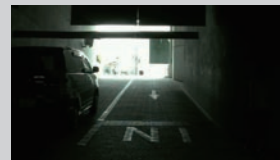

OFF



ON

Actual Images

XDNR (eXcellent Dynamic Noise Reduction) (Images 3)



OFF

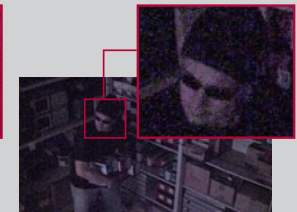

ON

Actual Images

SPECIFICATIONS

SNC-CH180	
Camera	
Image device	1/3 type progressive scan Exmor CMOS sensor
Minimum illumination	TBD
Number of effective pixels (H x V)	1.4 Megapixel (1329 x 1049)
Electronic shutter speed	1s to 1/10000s
Gain control	Auto (3 levels)
Exposure control	Auto, EV Compensation *1, Auto Slow Shutter *2
White balance mode	Auto (ATW, ATW-PRO), Preset, One-push WB, Manual
Lens type	Vari-focal lens
Zoom ratio	Optical 2.9X (x2 Digital Zoom)
Horizontal viewing angle	85.4 to 31.2 degrees
Focal length	f=3.1 to 8.9mm
F-number	F1.2 (Wide), F2.1 (Tele)
Minimum objects distance	300 mm
Powered Focus	Yes (Easy Focus)
Powered Zoom	Yes (Easy Zoom)
IR illuminators	Yes (Wave Length: 850nm [Typical], IR LED: 27pcs)
Camera Features	
Day/Night *3	Yes
Wide-D	View-DR (approx. 125dB: Theatrical)
Image enhancement	Visibility Enhancer
Noise reduction	XDNR
Image	
Codec image size (H x V)	1280 x 1024, 1280 x 960, 1280 x 800, 1280 x 720, 1024 x 768, 1024 x 576, 800 x 480, 768 x 576, 720 x 576, 720 x 480, 704 x 576, 640 x 480, 640 x 368, 384 x 288, 320 x 240, 320 x 192 (H.264, MPEG-4, JPEG)
Video compression format	H.264, MPEG-4, JPEG
Codec streaming capability	Dual streaming
Maximum frame rate	H.264: 20fps (1280 x 1024) / 30 fps (1280 x 720) MPEG-4: 25fps (1280 x 1024) / 30 fps (1280 x 720) JPEG: 30fps (1280 x 1024) / 30 fps (1280 x 720)
Audio	
Audio compression	G.711/G.726
Scene Analytics	
Intelligent motion detection	Yes (with built-in Post Filter)
Intelligent object detection	No
Rule filter	Yes
Network	
Protocols	IPv4, IPv6, TCP, UDP, ARP, ICMP, IGMP, HTTP, HTTPS, FTP (client/server), SMTP, DHCP, DNS, NTP, RTP/RTCP, RTSP, SNMP (MIB-2)
ONVIF software	Yes
Wireless network	Yes (with Option **)
Number of clients	10
Authentication	IEEE802.1X
Analog Video Output	
Signal system	NTSC / PAL
Horizontal resolution	600 TV lines
S/N ratio	More than 50dB
Interface	
Ethernet	10BASE-T / 100BASE-TX (RJ-45)
Serial interface	No
Card slots	CF card x1
Analog video output	BNC x 1, RCA x 1
Sensor input	x 1
Alarm output	x 2
External microphone input	Mini-jack (Monaural), MIC IN/LINE IN: 2.5VDC plug-in power
Audio line output	Mini-jack (Monaural), Max output level: 1 Vrms
General	
Weight	3 lb 8 oz (1600 g)
Dimensions (W x H x D)	3 3/8 x 3 5/8 x 7 3/8 inches (85 x 90 x 186 mm) 5 5/8 x 5 5/8 x 13 1/4 inches (140 x 140 x 334.8 mm) (including arm)
Power requirements	PoE *5, AC24V, DC12V
Power consumption	TBD
Starting temperature	AC24V/DC12V: -4 to +122°F (-20 to +50 °C) (Tentative) PoE (IEEE802.3af): 32 to 122°F (0 to 50 °C) (Tentative)
Working temperature	AC24V/DC12V: -22 to +122°F (-30 to +50 °C) (Tentative) PoE (IEEE802.3af): 23 to 122°F (-10 to +50 °C) (Tentative)
Storage temperature	-4 to +140°F (-20 to +60 °C)
Ingress protection	IP66
System Requirements	
Operating system	Windows XP, Windows Vista, Windows 7
Processor	Intel Core2 Duo 2 GHz or higher
Memory	1 GB or more
Web browser	Microsoft Internet Explorer Ver.6.0, 7.0, or 8.0
Supplied Accessories	
	CD-ROM (User's Guide, SNC Toolbox) Installation manual Wire rope M4 screw B&P Warranty Booklet Template

*1 VE off mode only. *2 View-DR off mode only. *3 Removable IR Cut Filter. *4 With optional SNCA-CFW5.

*5 When used with PoE, SNC-CH180 cannot be used with a heater and a CF card slot.

The SNC-CH180 includes software developed by the OpenSSL Project for use in the OpenSSL Toolkit (<http://www.openssl.org/>).

SYSTEM CONFIGURATIONS

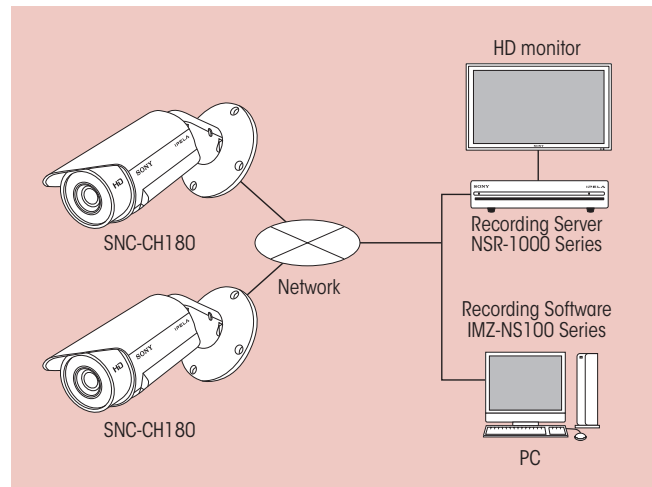

DIMENSIONS

Unit: inches (mm)

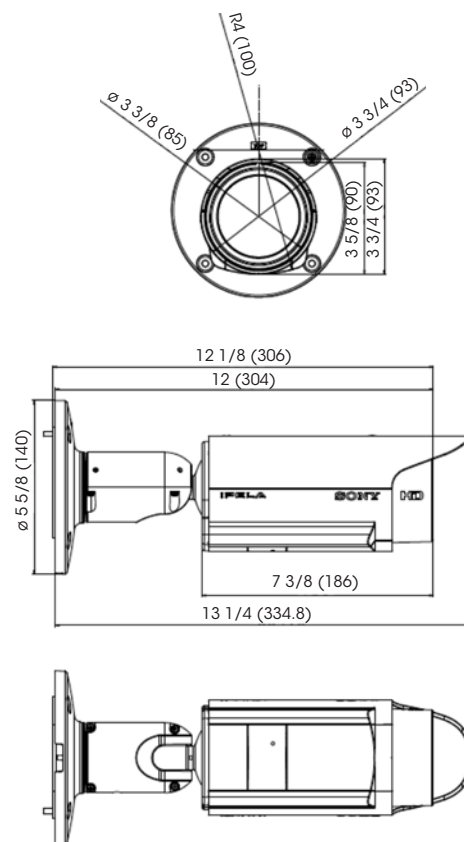

©2010 Sony Electronics Inc. All rights reserved.
 Reproduction in whole or in part without written permission is prohibited.
 Features and specifications are subject to change without notice.
 Weights and measurements are approximate.
 Sony, make.believe and their respective logos,
 DEPA, IPELA and Exmor are trademarks of Sony.
 Windows, XP, and Vista are trademarks of Microsoft Corporation.