



V2000-WIR-360 Series

Roughneck Pro Multi-Sensor Network Camera

Remote positioning multi-sensors for fast, easy and flexible installation



Overview

The Roughneck Pro Multi-Sensor cameras are engineered to simplify installation while delivering exceptional quality and performance. These powerful cameras boast advanced features such as starlight low-light imaging along with analytics to proactively alert operators of suspicious activity. They have four separate motorized high-resolution camera modules: the V2020-WIR-360 has four 5 MP camera modules to create a 20 MP camera, while the V2032-WIR-360 has four 8 MP camera modules, resulting in a 32 MP camera.

Reduce Installation Time and Frustration

All four sensors are motorized, so users can quickly and easily configure them remotely from a computer. The cameras include multiple presets for 180°, 270° or 360° coverage, though operators and installers can customize and save preset views through each sensor's PTZ controls to achieve completely custom views to meet the specific demands of their operations.

Exceptional Imagery, Day or Night

The Roughneck Pro Multi-Sensor cameras are engineered to deliver clear images day or night. True WDR ensures the camera can overcome high-contrast lighting conditions during the day, while 131 ft of IR illumination ensures that every detail can be seen at night. These cameras also feature starlight low-light imaging to capture clear, color footage in extremely low light scenes. This helps operators see critical forensic details, such as vehicle or clothing color, when traditional cameras would show black-and-white IR images.

Product at a Glance

- ▶ Four 5 MP or 8 MP sensors deliver an impressive 20 MP or 32 MP overall resolution
- ▶ Setup and reposition cameras in seconds, right from your computer
- ▶ Pre-defined presets deliver 180°, 270° and 360° views, and you can define additional presets of your own*
- ▶ See color images in near total darkness - no need for the camera to switch to B&W mode
- ▶ Four independent sensors, but only a single IP and Ethernet cable required
- ▶ NDA/GSA/TAA compliant

The camera can be used with Vicon Valerius as well as many other popular VMS systems. Each VMS may support different camera functions; check the VMS website for full support information.

*Remote positioning and presets are not for continuous use but for installation purposes only.

Specifications

Model	V2020-WIR-360	V2032-WIR-360
Camera		
Device Type:	Indoor/outdoor multi-sensor panoramic cameras	
Image Sensor:	4X 1/2.8" 5 MP CMOS progressive scan Starlight	4X 1/1.8" 8 MP CMOS progressive scan Starlight
Max Resolution:	4X 2592 x 1944 (5 MP)	4X 3840 x 2160 (8 MP)
Image Settings:	WDR (Wide Dynamic Range; 120 dB). Backlight Compensation (BLC). Configurable brightness, contrast, saturation, sharpness. Mirror. Flip. White balance. Exposure. Gain Control. Privacy masks (5). Day/night, True day/night ICR. Audio. Event handler and notifications.	
Video Content Analysis:	Video Motion Detection (VMD; 5 areas); Tampering; Intrusion; Line Counting/Crossing; Area Counting; Museum Search	
Electronic Shutter Speed:	1/7 ~ 1/20,000 sec	
Day/Night Performance:	True Day/Night with mechanical IR cut filter; Auto, Forced Day, Forced Night and Scheduled	
Wide Dynamic Range (WDR):	120 dB, True WDR	
IR Distance:	Up to 131 ft (40 m)	
Min Illumination @30 IRE:	Color: 0.03 lux; B/W: 0.01 lux, IR Off; 0 lux, IR On	Color: 0.02 lux; B/W: 0.01 lux, IR Off; 0 lux, IR On
Preset Positions:	360°, 270° Wide, 270° Tele, 180° Wide, 180° Tele, User Defined (2)	
Adjustment:	Remotely adjustable: Pan: 360°; tilt: 90°; each module can be positioned remotely along a track	
Lenses		
MFZ Lens:	4x 3.1 - 10 mm; 3.2X optical zoom	4x 3.6 - 10 mm; 2.8X optical zoom
Angle of View Horizontal/Vertical/Depth:	32° (tele) - 96° (wide)/24° (tele) - 69° (wide)/40° (tele) - 124° (wide)	46° (tele) - 98° (wide)/26° (tele) - 54° (wide)/54° (tele) - 113° (wide)
Network Video Transmission		
Network:	10/100 Mbps Ethernet; RJ-45	
Image Compression:	H.265/H.264 and M-JPEG	
Streaming:	Triple streaming	
Max. Frame Rate:	Up to 30 fps at 20 MP	Up to 30 fps at 32 MP
Audio:	Two way audio: 1 audio input, 1 audio output; G.711 8 KHz/8 bits	
Protocols:	IPv4/IPv6; TCP/IP; UDP; SNMP v2c/v3; HTTP; RTP; RTSP; RTCP; SMTP; HTTPS; UPnP; FTP; SSL; DNS; NTP; QoS; LDAP (client); DynDNS; Zeroconfig; ONVIF S, G, T, Q	
Users:	Up to 10 clients	
Web Browser:	Internet Explorer®; Mozilla Firefox®; Google Chrome®	
Security:	Password protection, IP address filtering, HTTPS, IEEE 802.1X network access control	
Alarms	1 alarm input, 1 alarm output	
Mechanical and Electrical		
Pan/Tilt Range:	Remote adjustment: Pan: 360°; Tilt: 90° (Default value 83°)	
Construction:	Die-cast aluminum housing; polycarbonate dome	
Mounting:	Surface-mounted; mounting holes provided; includes mounting cap. Mounting options available.	
Controls and Connectors:	I/O cable assemblies supplied for power, audio (2X) and Alarms. PoE/Network: RJ-45. Alarm In/Out: terminal blocks. Power: 2-pin terminal block. Audio In/Out: phone jacks. SD card (2X).	
Dimensions:	H: 5.6 in. (142.3 mm); Diam: 9.7 in. (247.5 mm); refer to dimensional diagram	
Weight:	7.55 lb (3.425 kg)	
Input Power:	PoE++ (IEEE802.3bt Class 5); 24 VDC; 24 VAC	
Current:	1.7 A	
Power Consumption:	40 W max	
Environmental		
Operating Conditions:	Temp: -40° to 131° F (-40° to 55° C) IR Off. Humidity: Up to 90%, relative, non-condensing.	
Approvals:	FCC Class A, CE, IP66, IK10; UL	
Country of Origin:	Taiwan	
Warranty:	5 years	

Connectors

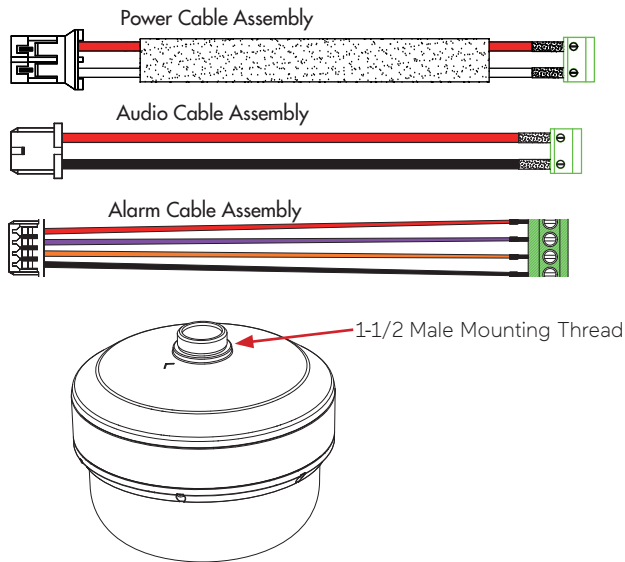

Dimension Drawing

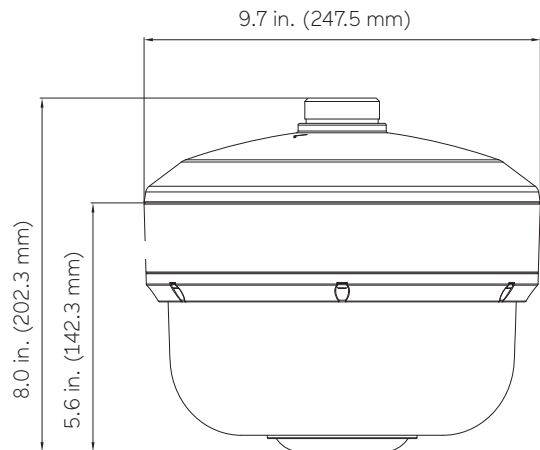

Ordering Information

Model Number	Resolution	Lens	Environment
V2020-WIR-360	4X 2592 x 1944 pixels (20 megapixel)	4X 3.1-10 mm MFZ	Indoor/Outdoor
V2032-WIR-360	4X 3840 x 2160 pixels (32 megapixel)	4X 3.6-10 mm MFZ	Indoor/Outdoor
Model Number	Accessories Description		
V1001-WM	Wall mount for the V1000/V2000 series of multi-sensor cameras		
V1001-PM	Pendant mount for the V1000/V2000 series of multi-sensor cameras		
V2000-360-ICD	In-ceiling mount for installation in a drop ceiling		
V1001-ADAPT	Adapter plate; used when mounting the wall mount to the V-20B-A-4 pole mount or V-24CMB-4 corner mount bracket		
V-24CMB-4	Corner mounting bracket; adapter plate required		
V-20B-A-4	Pole mount adapter; adapter plate required		
SVFT-UPM-2	Parapet mount		
VPOE-INJ-60BT	Single-port PoE gigabit injector; compatible with IEEE802.3bt; 60 W output		



V1001-WM



V2000-360-ICD



V1001-PM



V1001-ADAPT



V-24CMB-4



V-20B-A-4



SVFT-UPM-2

Data Sheet Number: V322-21-02

Vicon Data Sheet Number: 8009-7322-21-02

Specifications subject to change without notice.

Vicon and their logos are registered trademarks of Vicon Industries Inc.

Copyright © 2022 Vicon Industries Inc. All rights reserved.

Explorer is a registered trademark of Microsoft Corporation.

Chrome is a registered trademark of Google LLC.

Firefox is a registered trademark of Mozilla Corp.

Safari is a registered trademark of Apple Inc.